

PRODUCTS SHOWN ARE FIXED VERSIONS.
 FOR TIPPING ADD A ROTATOR: SEE SALESBOOKS SECTIONS ML80-7900. ML300-7900

ML80-7030

For Euro Crates - a lip on the forks goes under the edge of the crate

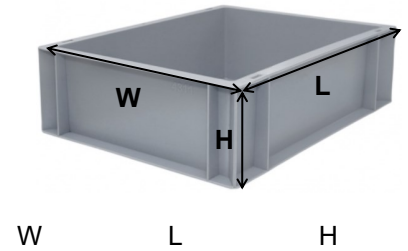
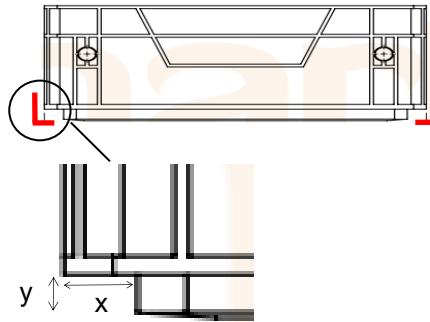
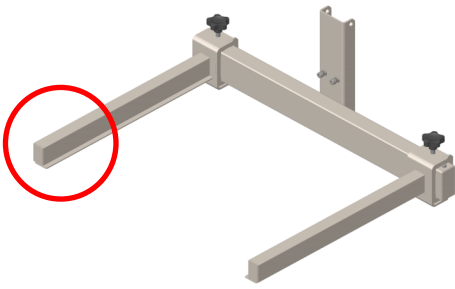

ML80-7031

Forks that slide into the recess on the sides of the crate

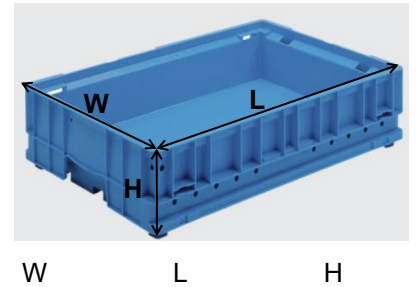
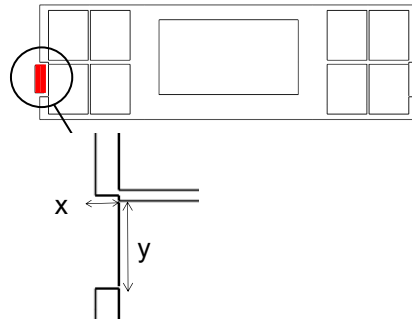
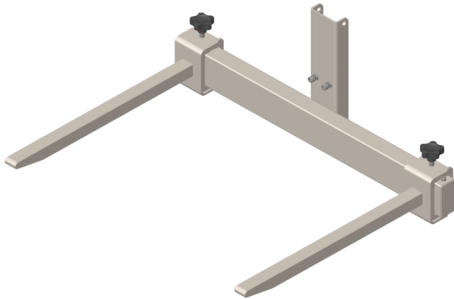

ML80-7032

Forks with floating fingers: the forks are lowered down onto the crate and the fingers fall into spaces on the sides of the crate. To release, go down a few mm and pull the forks backwards - the round shape of the fingers float over

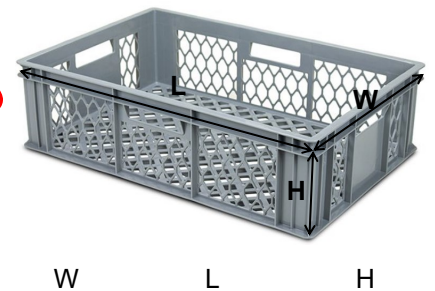
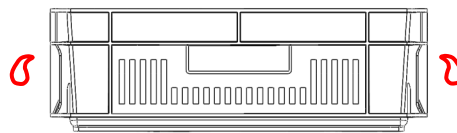
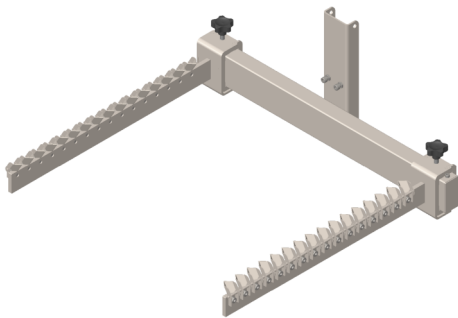

ML80-7033 Forks shape as U channels which hold the crate by the lip on the side

